

MAXIM

MAX3840 Evaluation Kit

Evaluates: MAX3840

General Description

The MAX3840 evaluation kit (EV kit) is a surface-mount demonstration board that provides easy evaluation of the MAX3840 2.7Gbps, dual 2x2 crosspoint switch. The board includes an extra transmission line for calibration purposes.

The MAX3840 EV kit is fully assembled and tested.

Component List

DESIGNATION	QTY	DESCRIPTION
C1	1	33 μ F \pm 10% tantalum capacitor
C2	1	2.2 μ F \pm 10% tantalum capacitor AVX TAJC225K016
C3–C24, C27, C29–C31	26	0.1 μ F \pm 10% ceramic capacitors (0402)
R1–R8	8	1k Ω \pm 1% (0402) resistors
R9–R12	4	100 Ω \pm 1% (0402) resistors
L1	1	4.7 μ H inductor, Coilcraft
U1	1	MAX3840EGJ, 32-pin QFN EP
JP1–JP8	8	1x2 pin headers (0.1in centers)
JP1–JP8	8	Shunts Digi-Key S9000-ND
J1–J20	20	SMA connectors (edge-mount)
J21, J22	2	Test points
None	1	MAX3840 Evaluation Kit circuit board
None	1	MAX3840 Evaluation Kit data sheet
None	1	MAX3840 data sheet

Features

- ◆ Fully Assembled and Tested Surface-Mount Board
- ◆ +3.3V Single Supply
- ◆ Includes Transmission Line for Calibration
- ◆ Part Assembled in a 32-pin QFN Exposed-Pad (EP) Package

Ordering Information

PART	TEMP. RANGE	IC PACKAGE
MAX3840EVKIT	-40°C to +85°C	32 QFN-EP

Component Suppliers

SUPPLIER	PHONE	FAX
AVX	803-946-0690	843-626-3123
Digi-Key	218-681-6674	218-681-3380
Murata	814-237-1431	814-238-0490

Note: Please indicate that you are using the MAX3840 when contacting these component suppliers.

MAX3840 Evaluation Kit

Detailed Description

The MAX3840 EV kit simplifies evaluation of the MAX3840 dual 2×2 crosspoint switch. The EV kit operates from a single +3.3V power supply and includes all external components necessary to interface with the CML inputs and outputs.

The CML inputs (DIA_ and DIB_) are internally terminated on the MAX3840 with 100Ω differential input resistance and require no external termination. Ensure that the CML devices driving these inputs are not redundantly terminated. The CML outputs (DOA_ and DOB_) must be AC-coupled to a 50Ω termination (100Ω differential) load. On-board 100Ω differential terminations are provided to reduce noise outputs that are not used.

Connecting CML Outputs to 50Ω Oscilloscope Inputs

To monitor one or more CML signals with 50Ω oscilloscope inputs, leave the coupling capacitors in series with the outputs. Remove the associated 100Ω differential load resistors from the EV kit on the outputs (R9–R12). It is important to remove the 100Ω resistor on

the output monitored, otherwise the load impedance will not match the characteristic impedance of the line and the resulting reflections will cause a degradation in the output signal quality. If you are observing a single-ended output, balance the other half with a 50Ω termination to ground (through the AC-coupling capacitor).

Connecting CML Outputs to High-Impedance Oscilloscope Inputs

To monitor the CML signals with high-impedance oscilloscope inputs, leave the coupling capacitors in series with the outputs, and make sure the differential load resistors are on all the outputs on the EV kit (R9–R12).

Layout Considerations

The input and output data lines have equal lengths to minimize channel-to-channel skew.

Jumpers

Jumpers JP1, JP2, JP5, and JP6 select the input signals for channel A and B outputs. Jumpers JP3, JP4, JP7, and JP8 enable the output drivers for channel A and B (refer to Table 1).

Table 1. Output Routing

ROUTING CONTROLS		OUTPUT CONTROLS		OUTPUT SIGNALS	
SELA0/SELB0	SELA1/SELB1	ENA0/1	ENB0/1	SIGNAL AT DOA0/DOB0	SIGNAL AT DOA1/DOB1
0	0	1	1	DIA0/DIB0	DIA0/DIB0
0	1	1	1	DIA0/DIB0	DIA1/DIB1
1	0	1	1	DIA1/DIB1	DIA0/DIB0
1	1	1	1	DIA1/DIB1	DIA1/DIB1
X	X	0	0	Power Down	Power Down

MAX3840 Evaluation Kit

Board Effects

Evaluates: MAX3840

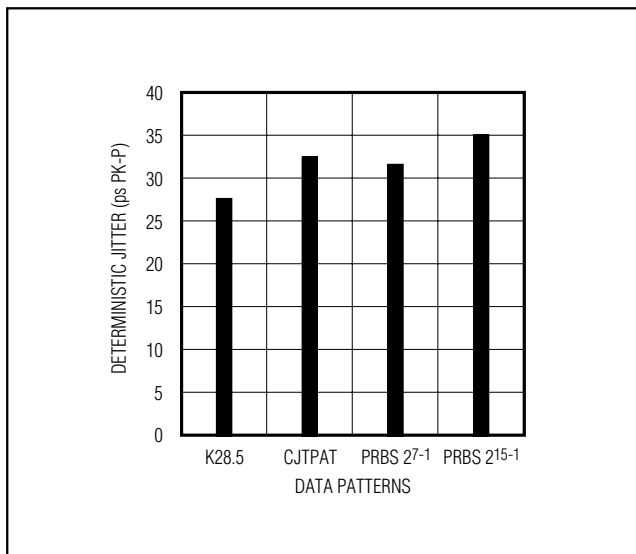

Figure 1. Deterministic Jitter From Board Traces
(Refer to application note HFAN-4.5.0, Rev 0, 12/00)

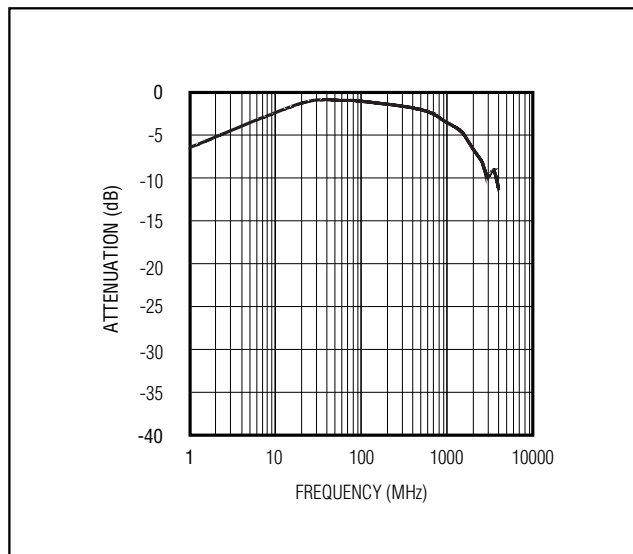

Figure 2. Attenuation vs. Frequency—Attenuation of Board Trace
(Refer to application note HFAN-4.5.0, Rev 0, 12/00)

MAX3840 Evaluation Kit

Evaluates: MAX3840

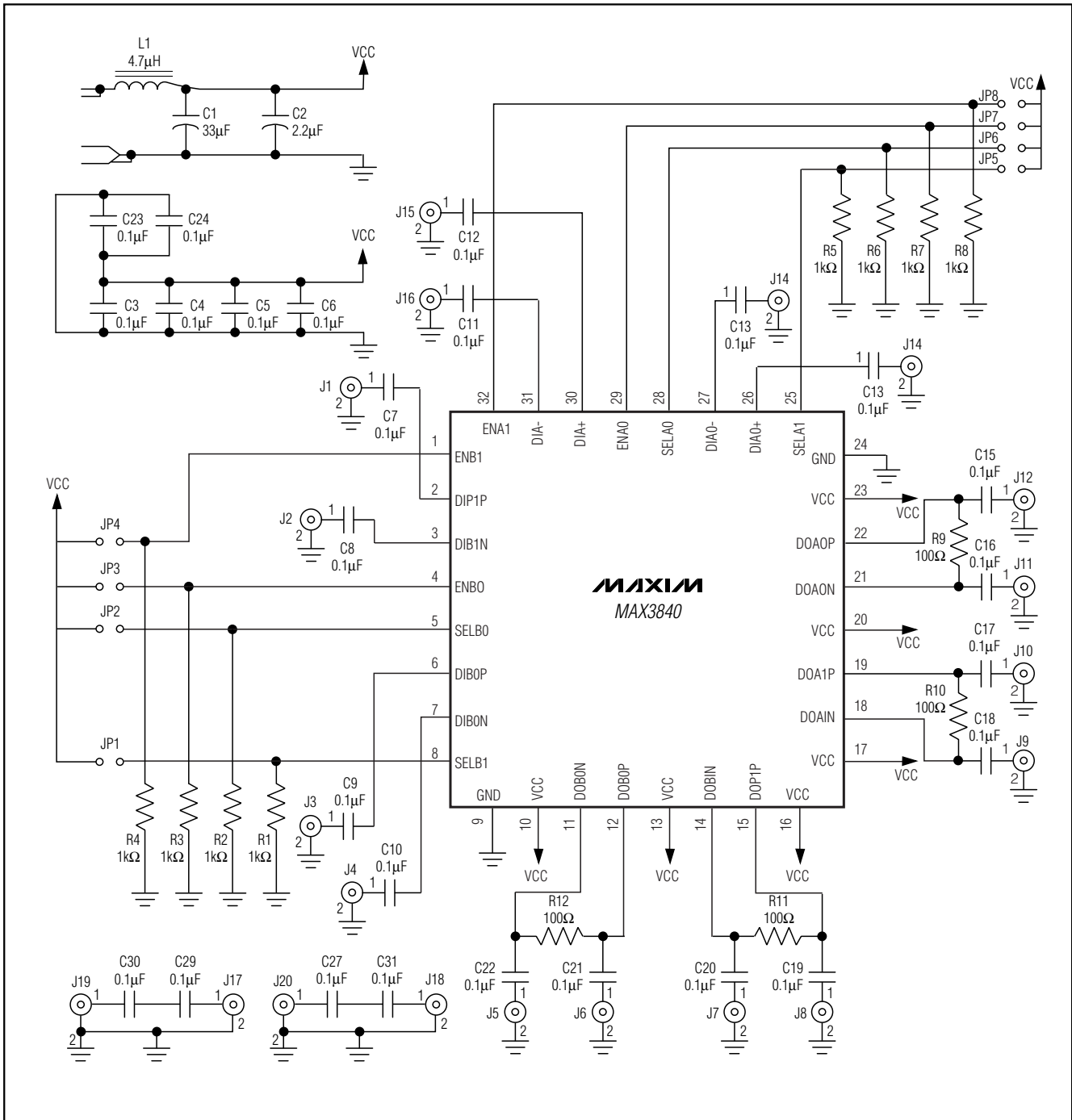

Figure 3. MAX3840 EV Kit Schematic Diagram

MAX3840 Evaluation Kit

Evaluates: MAX3840

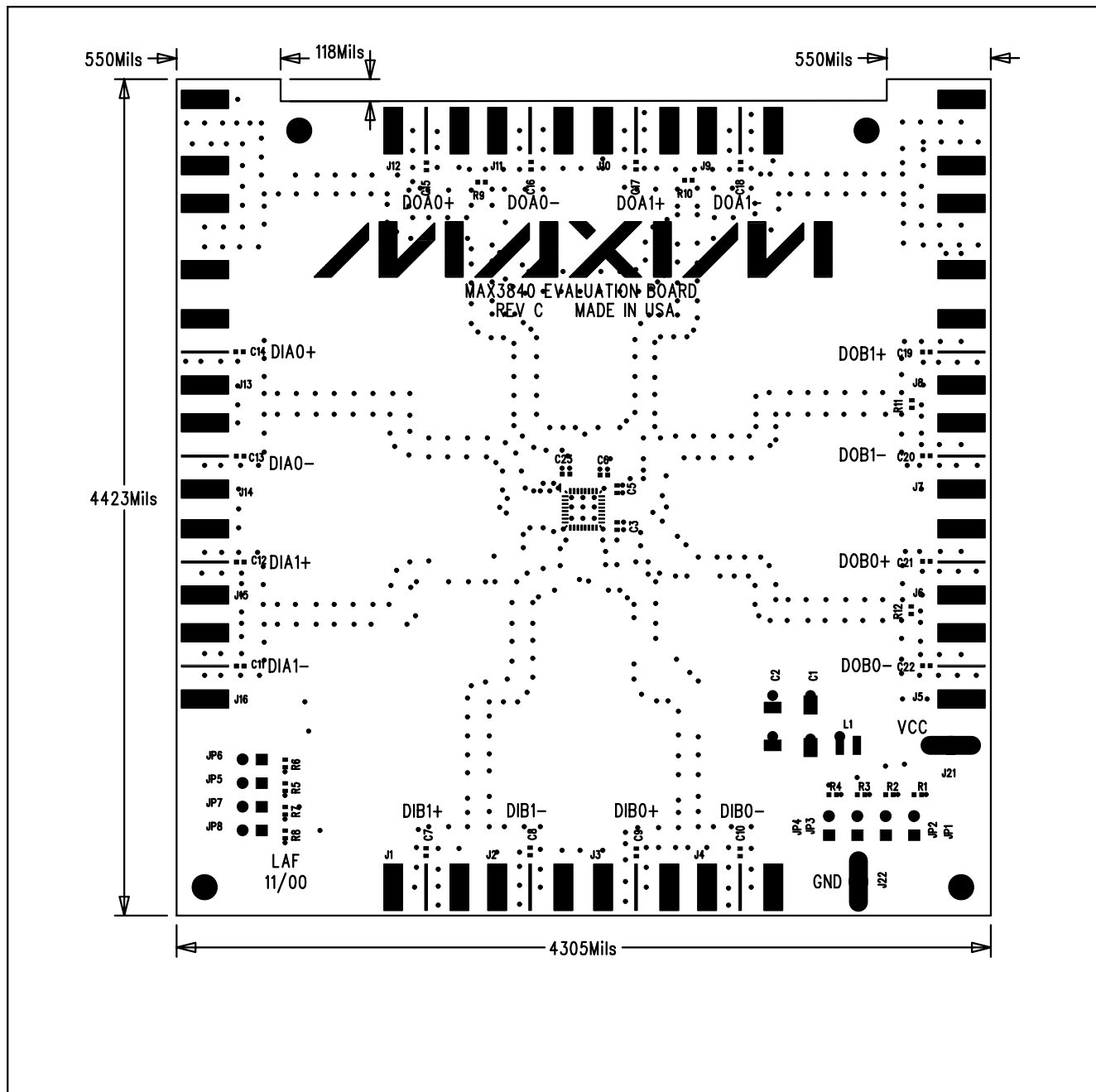

Figure 4. MAX3840 EV Kit Component Placement Guide—Component Side

MAX3840 Evaluation Kit

Evaluates: MAX3840

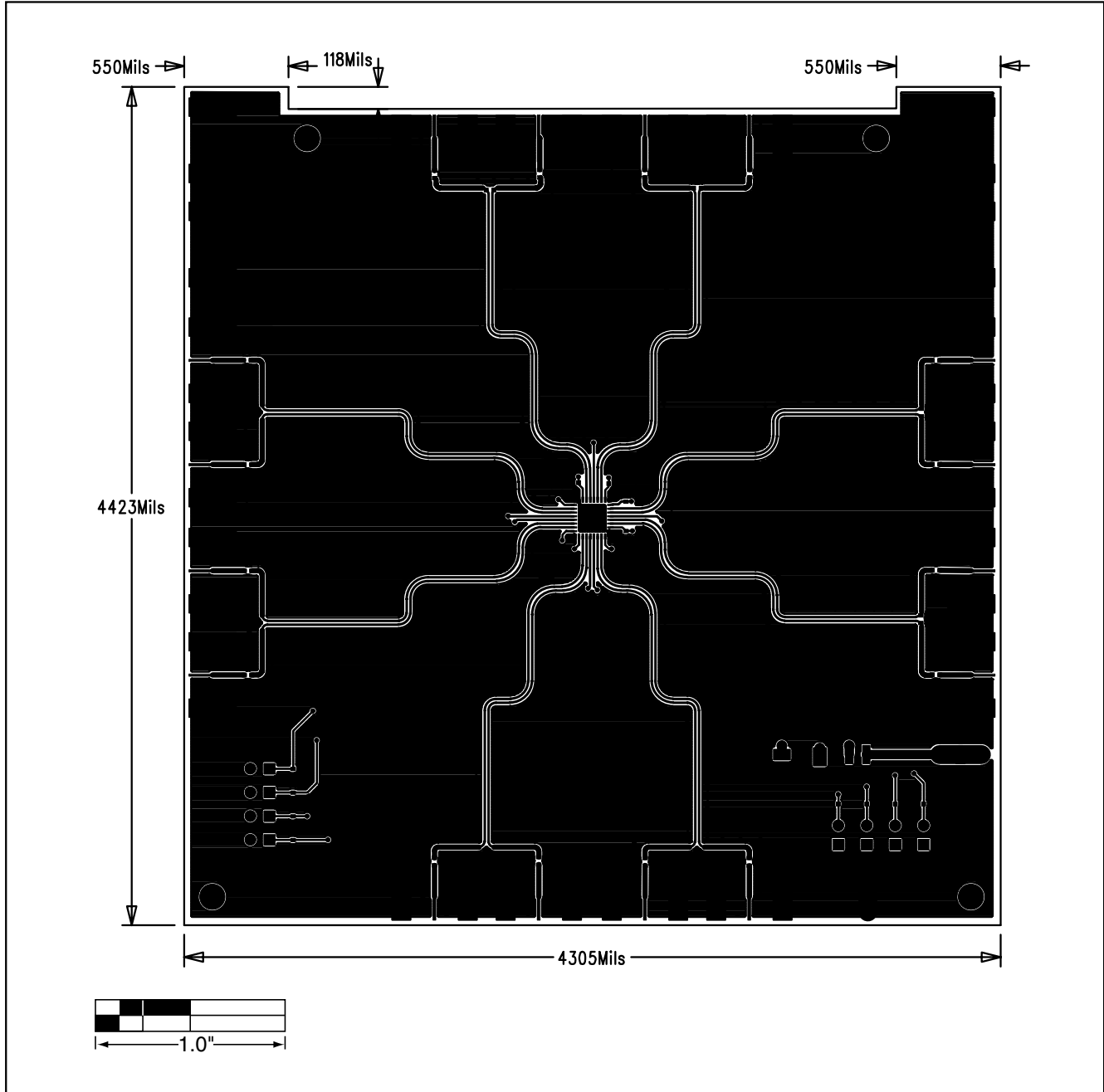

Figure 5. MAX3840 EV Kit PC Board Layout—Component Side

MAX3840 Evaluation Kit

Evaluates: MAX3840

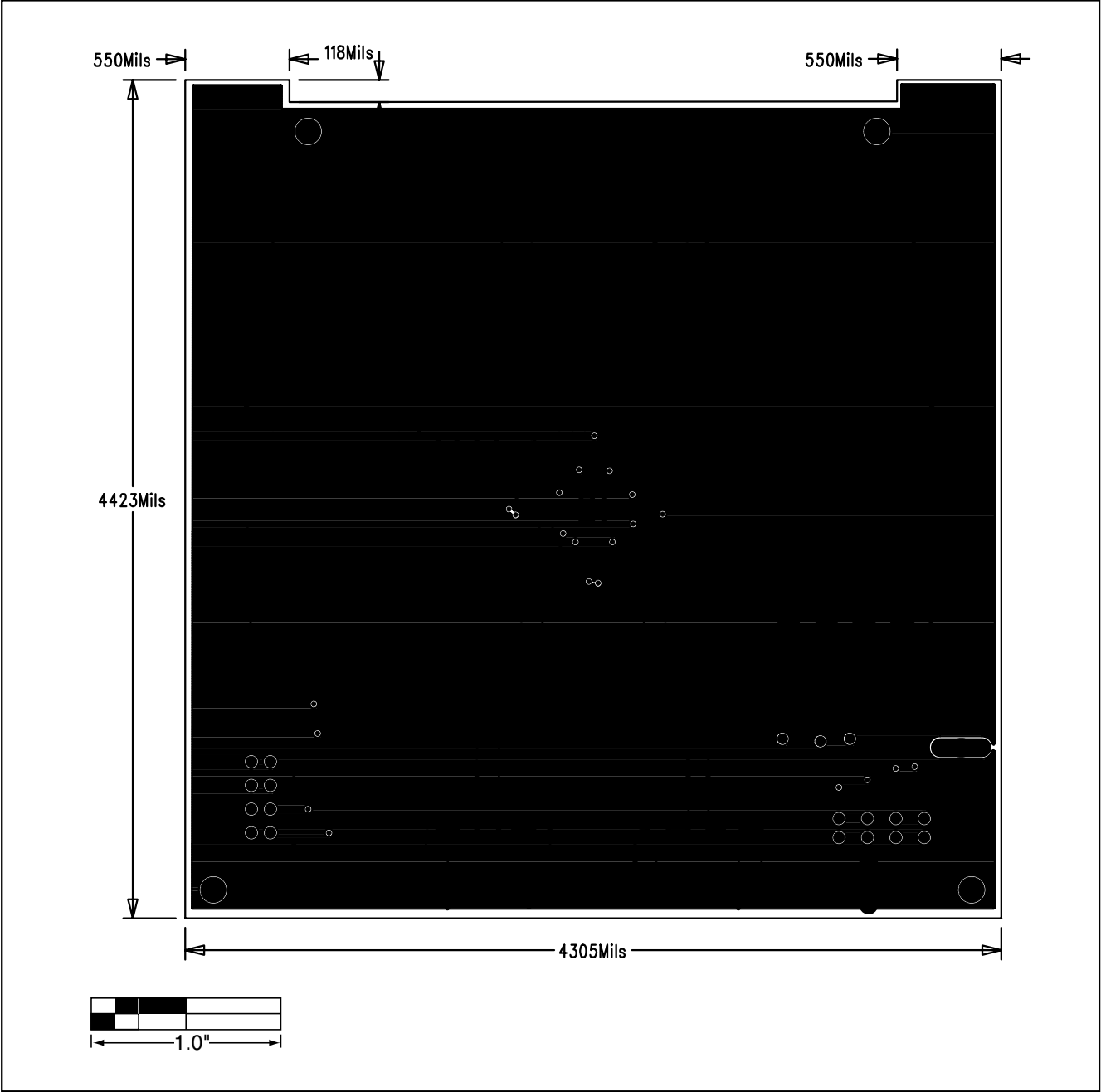

Figure 6. MAX3840 EV Kit PC Board Layout—Ground Plane

MAX3840 Evaluation Kit

Evaluates: MAX3840

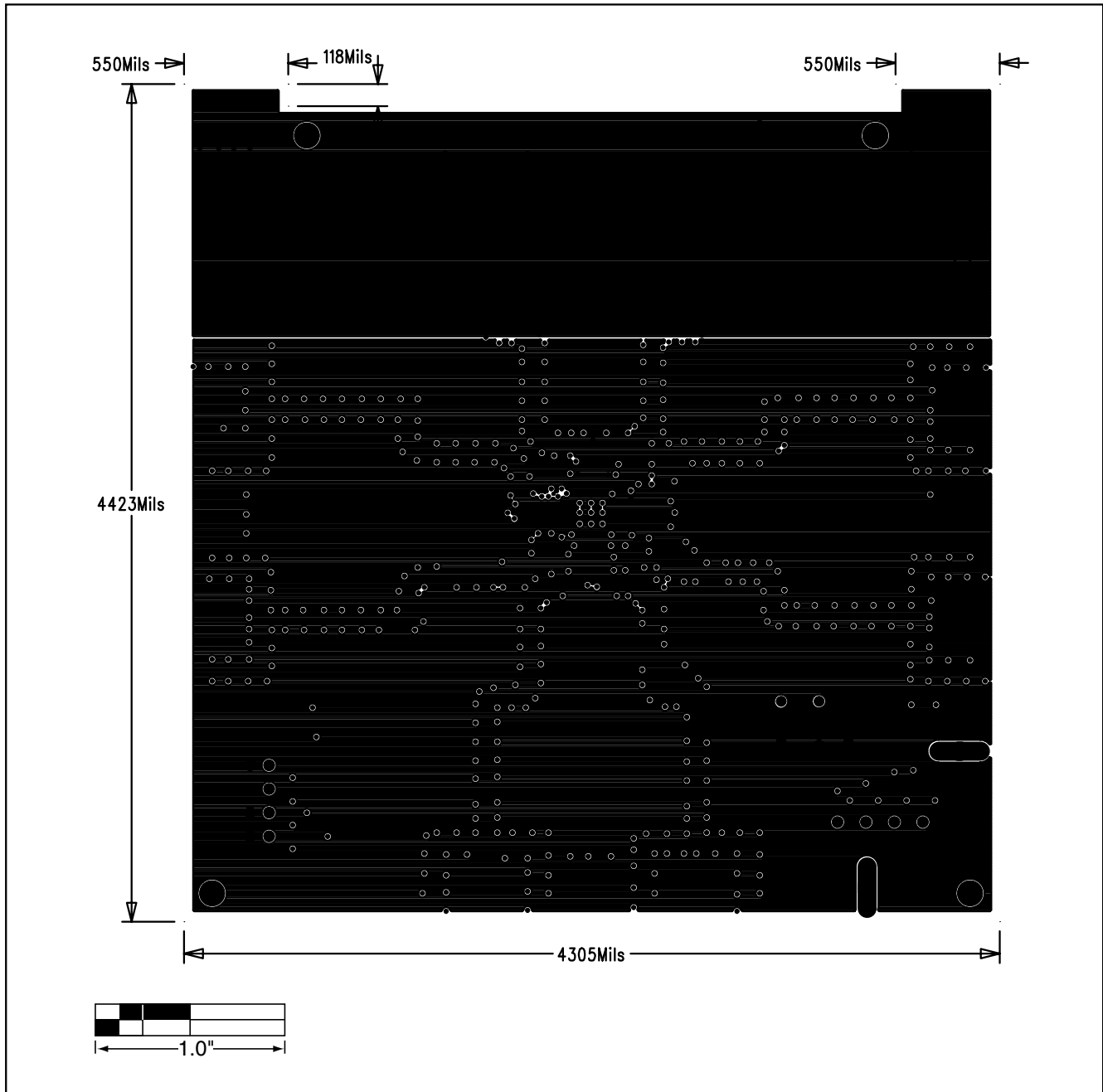

Figure 7. MAX3840 EV Kit PC Board Layout—Power Plane

MAX3840 Evaluation Kit

Evaluates: MAX3840

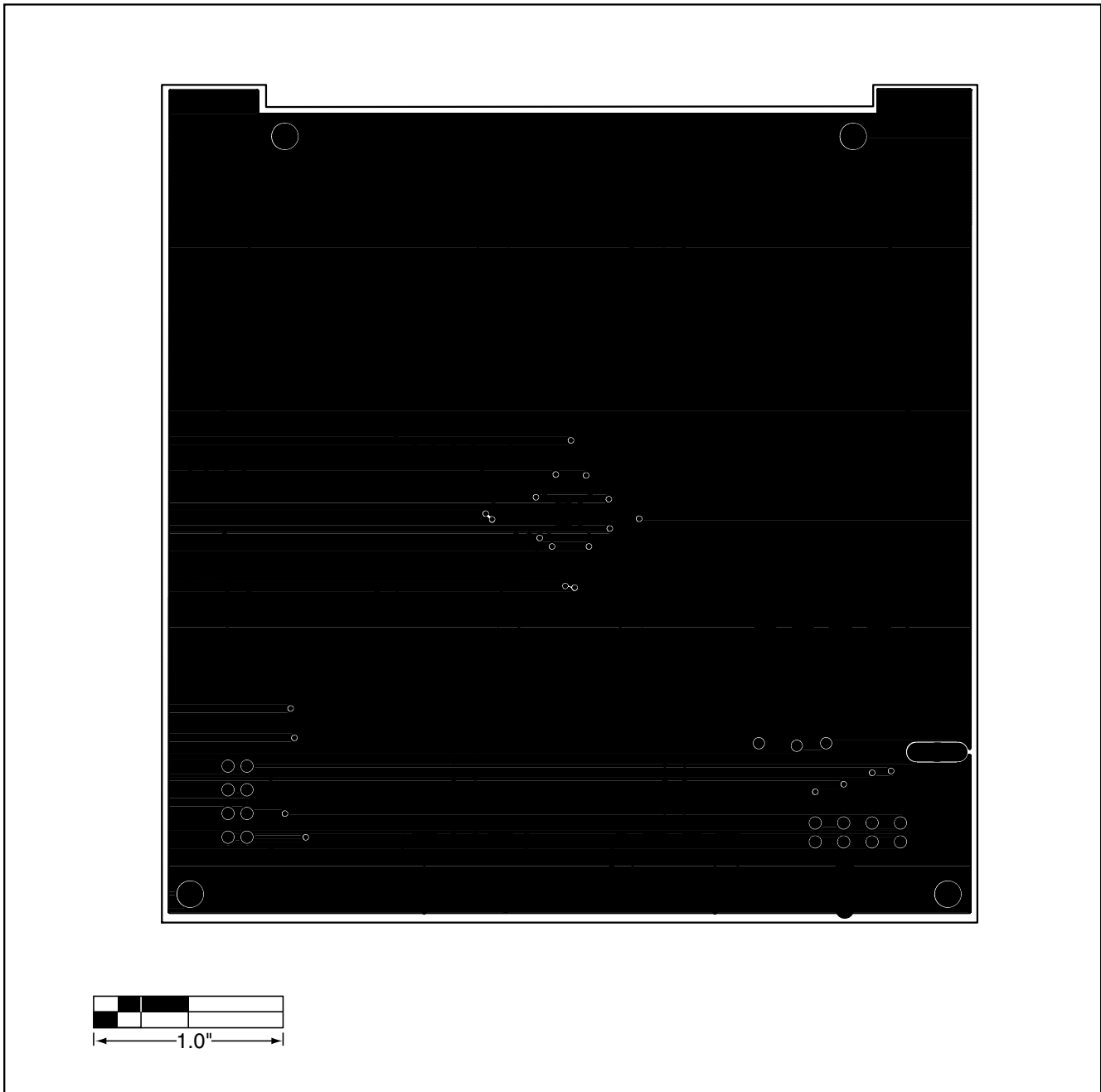

Figure 8. MAX3840 EV Kit PC Board Layout—Solder Side

Maxim cannot assume responsibility for use of any circuitry other than circuitry entirely embodied in a Maxim product. No circuit patent licenses are implied. Maxim reserves the right to change the circuitry and specifications without notice at any time.

9 **Maxim Integrated Products, 120 San Gabriel Drive, Sunnyvale, CA 94086 408-737-7600**

© 2001 Maxim Integrated Products

Printed USA

MAXIM is a registered trademark of Maxim Integrated Products.